

# AKABA



## *Carma*

Sistema de mesas modular con 4 alturas disponibles y diferentes formas de encimera; redonda, cuadrada, tonel, oval, trapezoidal,...

**Pata y nudos** en aluminio L-2630 inyectado de alta presión acabado pintado pulido bolas. Calidad UNE L-38263

**Topes a suelo** pequeños o grandes en polipropileno con taco nivelador, topes metálicos pintados en polvo con nivelador o ruedas con freno.

**Columnas** compuestas de tubo de acero de 60mm de diámetro y 2 mm de espesor

**Largueros** de tubo de acero 50x20 x 2mm en forma oval pintados en polvo o cromados.

**Cruceta** bajo encimera en aluminio inyectado de alta presión

**Encimeras** en melamina 20mm, compacto 13mm o madera chapeada 20mm.

**Acabados metálicos** pintura en polvo epoxi/poliéster de espesor 50-90 micras según color, adherencia ISO 2409 Gt 0 e impacto ASTM 2794 2,5 Joule D/R o acabado cromado composición 98,4 % NI 1,6 % CR, 24,4 micras de espesor y adherencia UNE EN ISO 2409-96 Clasificación 0

---

## CERTIFICADOS DE CALIDAD Y MEDIO AMBIENTE:

UNE-EN 527-1/3: 2003 Mesas de Trabajo. Work tables and desks. Tables de travail de bureau.

ISO 14006 Ecodesign.

EPD (Declaración medioambiental de producto, Environmental product declaration).

 Reciclable hasta un **99 %**.

# MEDIDAS

## CARMA CONFIGURACIONES

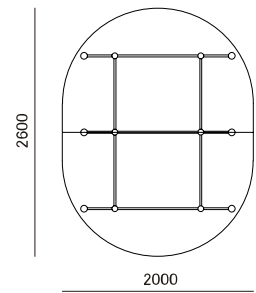
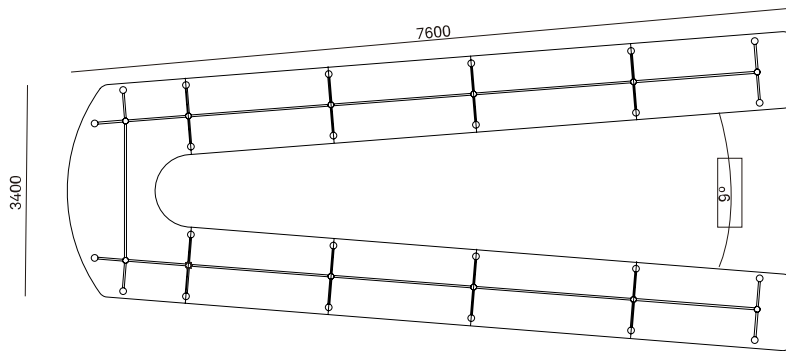
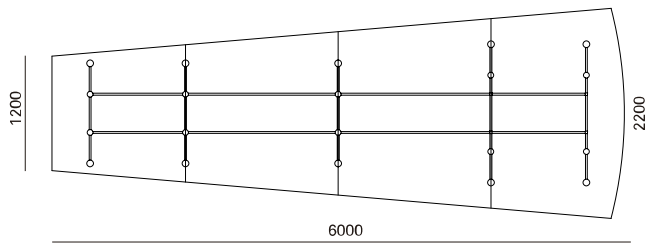
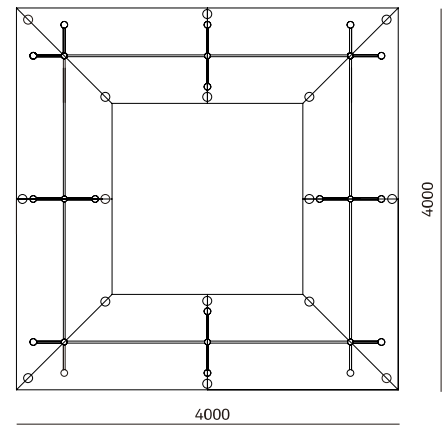
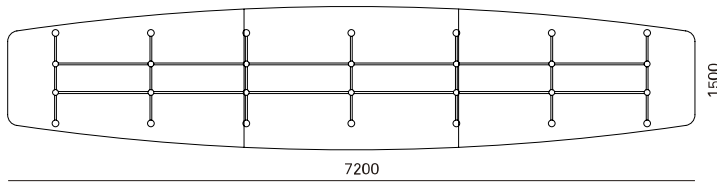
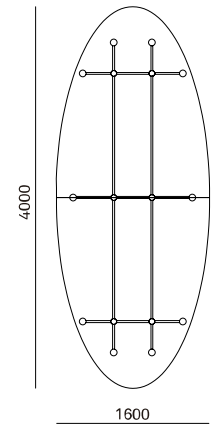
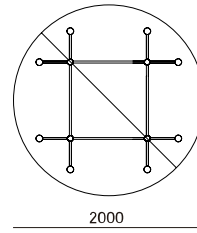
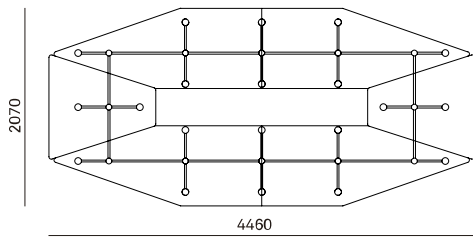
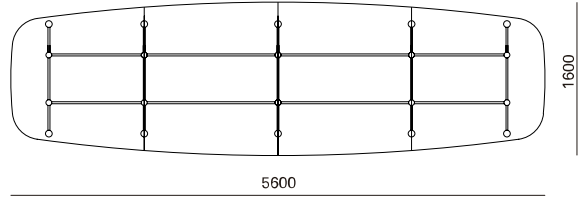
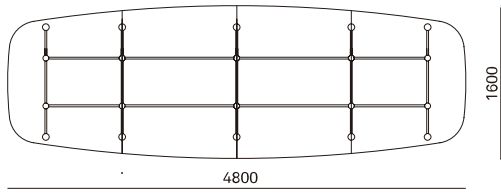

## CARMA

Pie corto con topes plástico

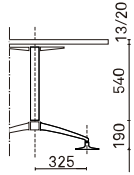

Pie corto con ruedas

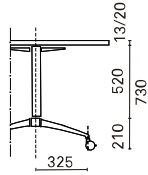

Pie corto con topes contract

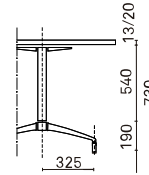

Larguero (medida entre ejes)

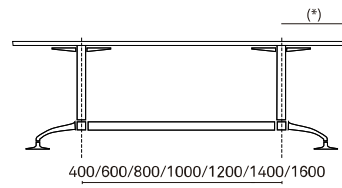

(\*)= Vuelo lateral recomendado 400mm

Topes plástico

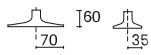

Topes contract

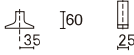

Ruedas



## CARMA

Pie largo con topes plástico

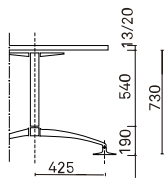

Pie largo con ruedas

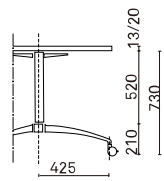

Pie largo con topes contract

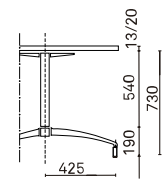

Larguero (medida entre ejes)

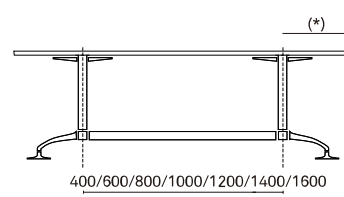

(\*)= Vuelo lateral recomendado 500mm

Topes plástico

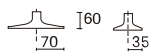

Topes contract



Ruedas



---

## ACCESORIOS



Tope contract / CR



Tope plástico  
pequeños / CR



Tope plástico  
grandes / CR

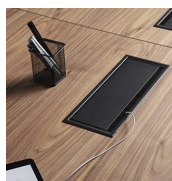

Top access / CR



Kit electrificación /  
CR  
Kit electrificación  
sobre encimera.



Kit electrificación /  
CR  
Kit electrificación  
apertura 50°.



Columna flexible /  
CR  
Columna flexible de  
electrificación.  
Blanco y negro.

---

## IMÁGENES



# AKABA

Atallu kalea 14  
20170 Usurbil (Gipuzkoa)  
Spain

akaba@akaba.net  
T +34 943 372 211  
F +34 943 371 052

© AKABA S.A. Todos los derechos reservados